

MATISA

Art.-Nr.

134 711
134 710
134 709

↗	2280
↖	2130
↘	620
	mm

1/8
v2





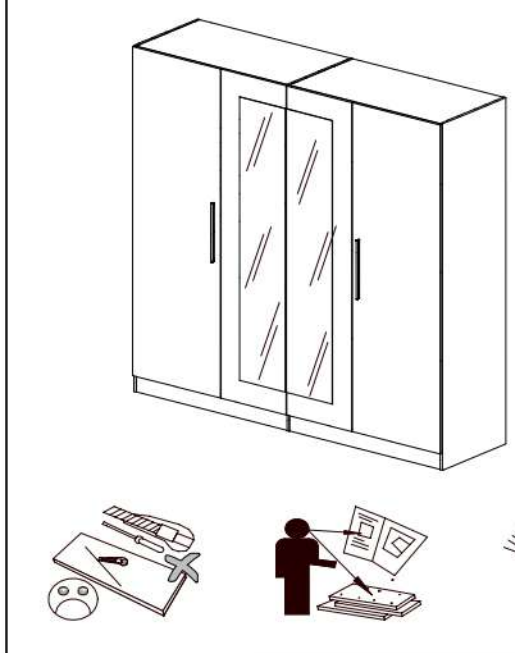
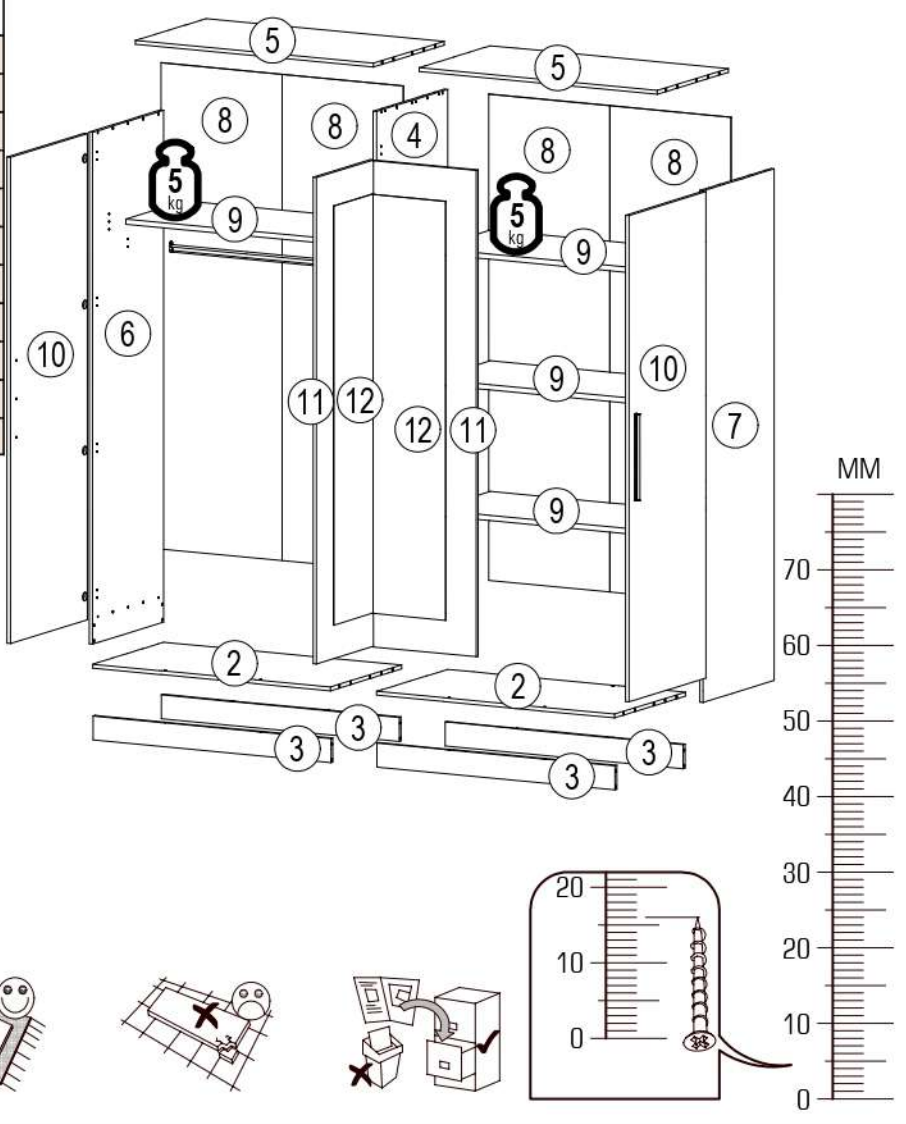

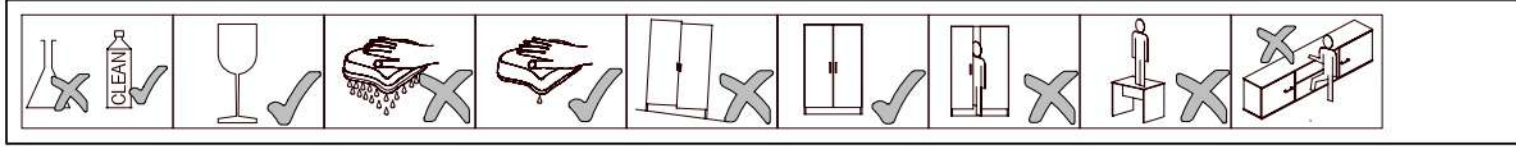

	100 min			PZ1, PZ2	0,5 kg	3m	600 mm	Ø8

ID	ID			
10796	②	599*1116*16	2x	2/5
10797	③	1116*100*16	4x	2/5
10798	④	2130*600*16	1x	1/5
10799	⑤	599*1116*16	2x	2/5
10800	⑥	2130*600*16	1x	1/5
10801	⑦	2130*600*16	1x	1/5
10802	⑧	2024*568*3	4x	4/5
10803	⑨	1116*500*22	4x	3/5
10804	⑩	2024*650*16	2x	4/5
10805	⑪	2024*482*16	2x	5/5
10806	⑫	1744*340*3	2x	5/5









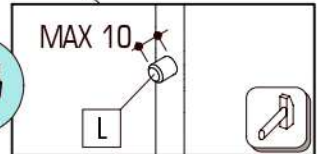
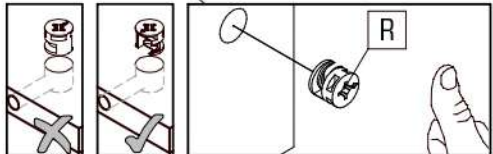
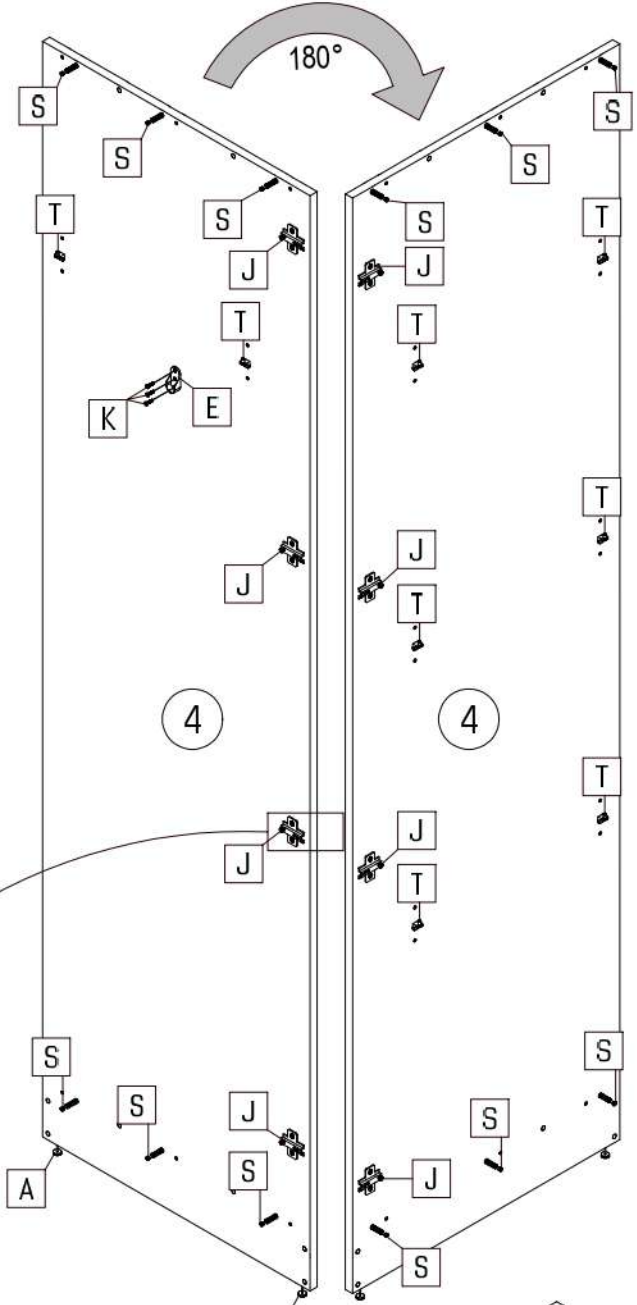
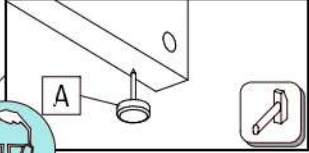
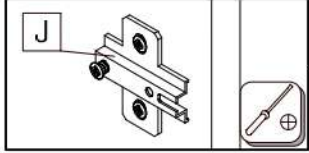
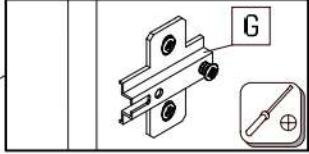
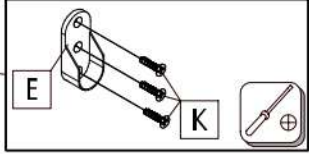
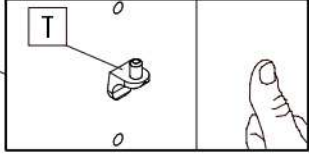
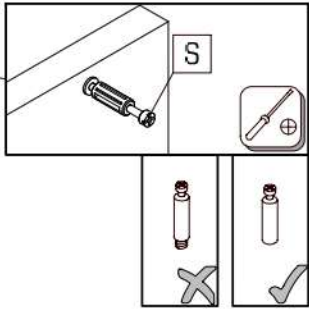
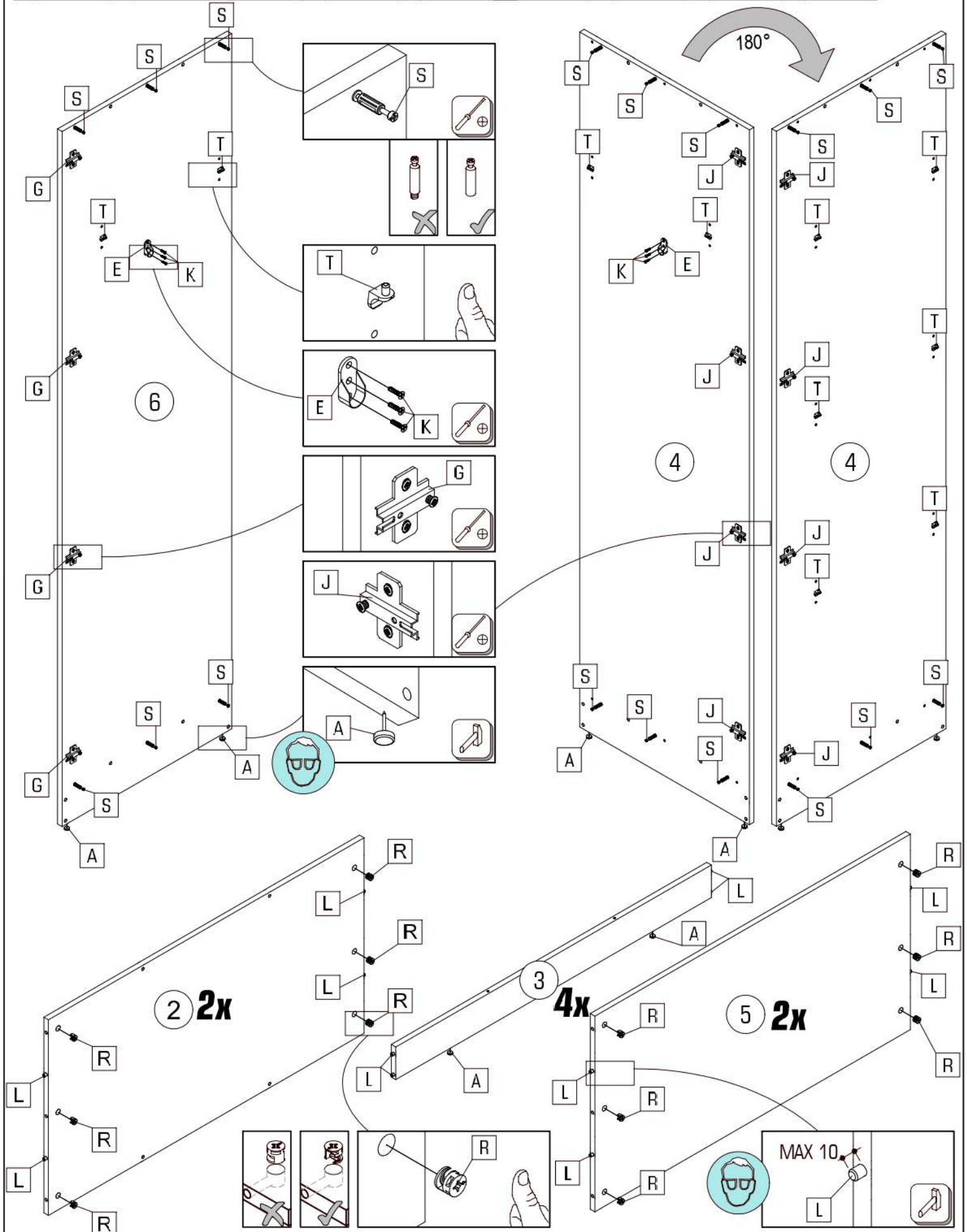

30091.00		22430.00		21102.00		32031.00		70018.01		36002.07		36002.07		36013.02		36013.02	
A	14x	B	6x	C	100x	D	2x	E	2x	F	8x	G	8x	H	8x	J	8x
22243.00		27000.00		70017.46		22300.00		22244.01				70013.01		70021.01		8501.00	
K	38x	L	32x	M	1x	N	8x	P	4x	Q	12x	R	24x	S	24x	T	16x
22236.00		24008.00		31103.00		22800.01		24103.00		22213.00							
U	20x	V	20x	W	2x	X	1x	Y	2x	Z	2x						



								
A 12x	E 2x	G 4x	J 8x	K 6x	L 32x	R 24x	S 18x	T 10x



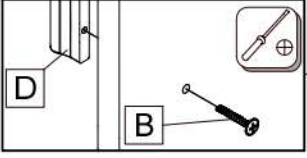
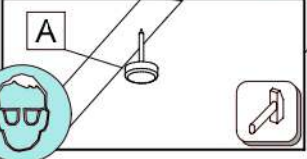
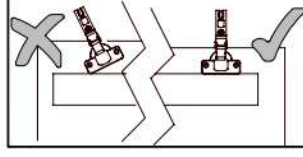
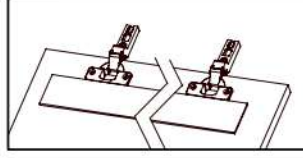
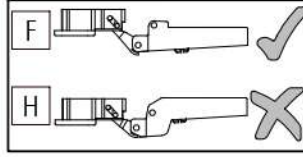
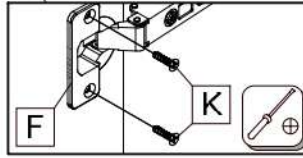
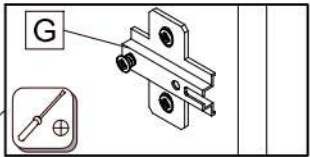
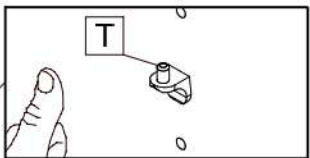
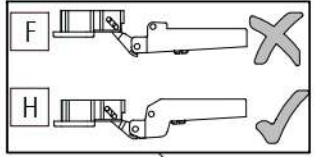
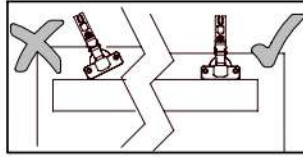
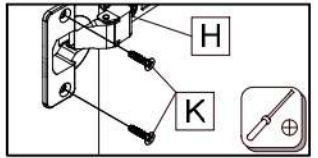
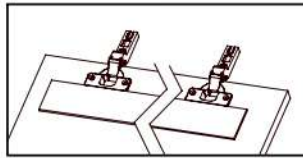
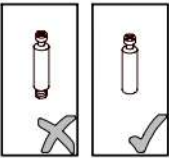
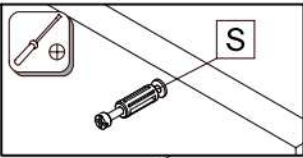
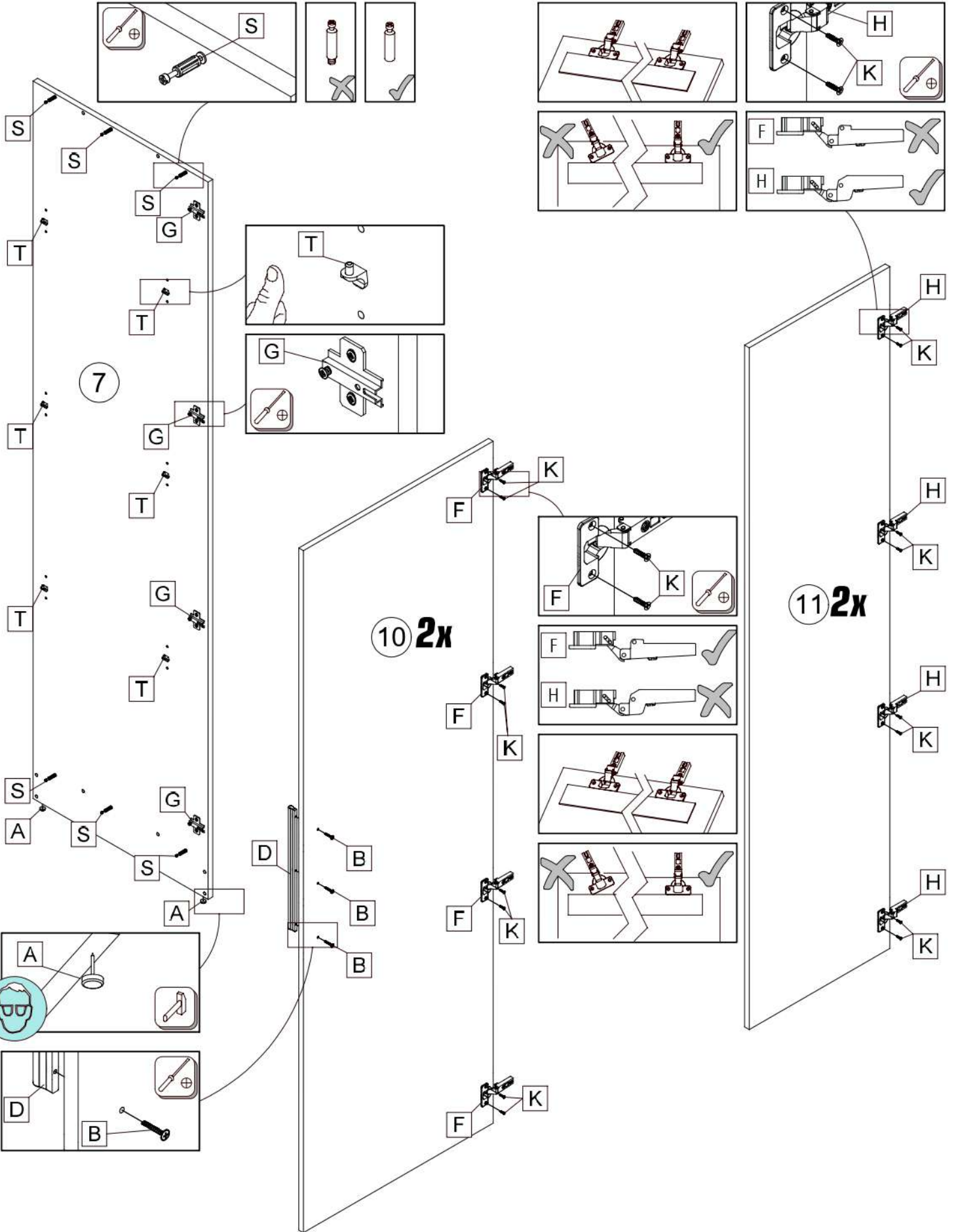

								
A 2x	B 6x	D 2x	F 8x	G 4x	H 8x	K 32x	S 6x	T 6x

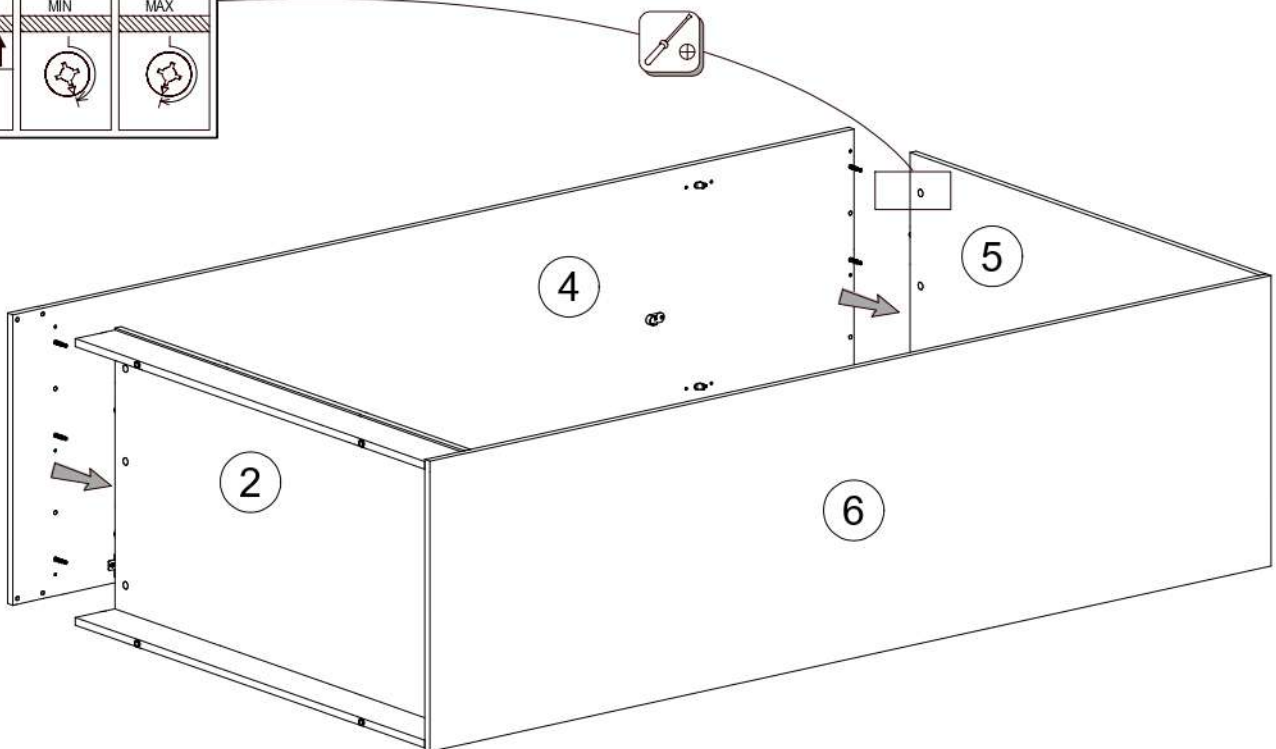
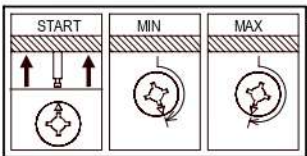
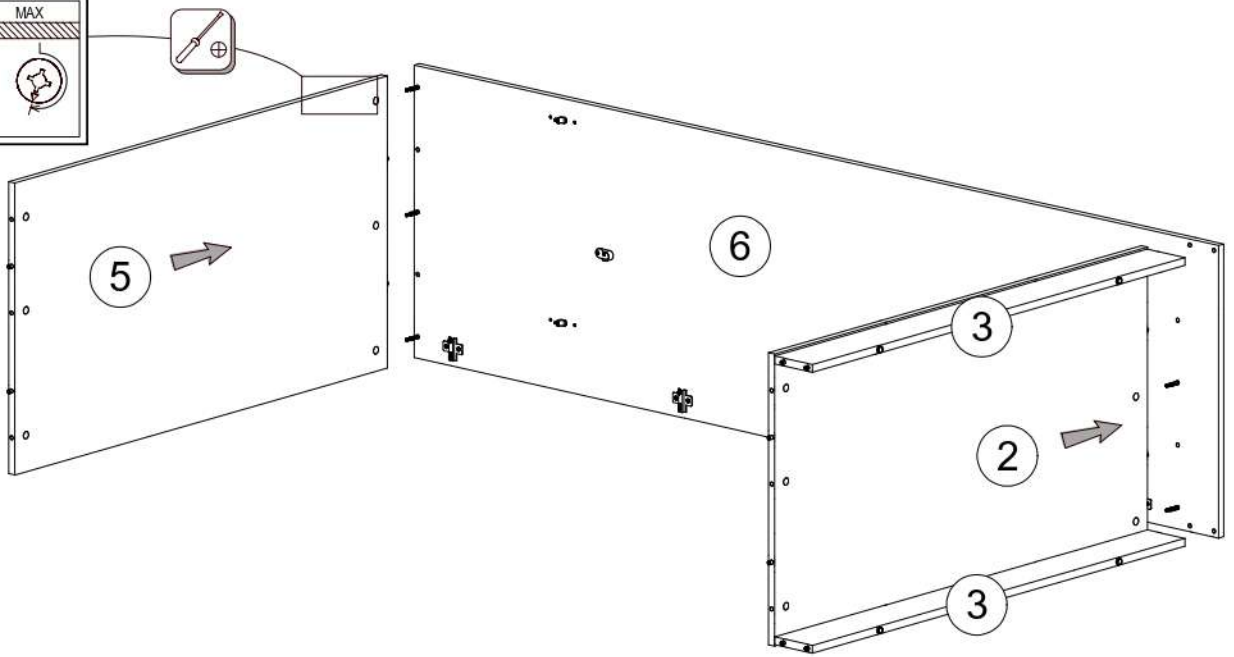
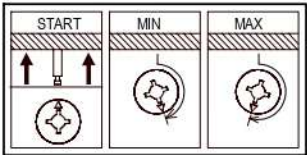
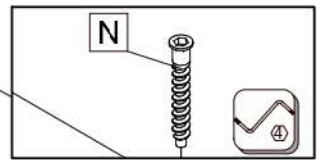
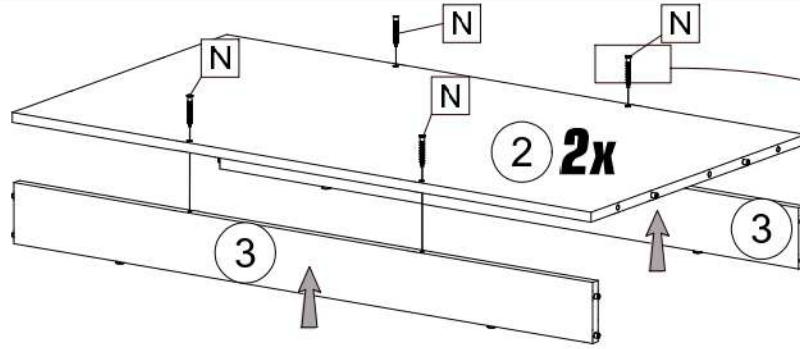
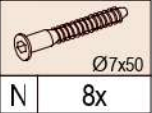

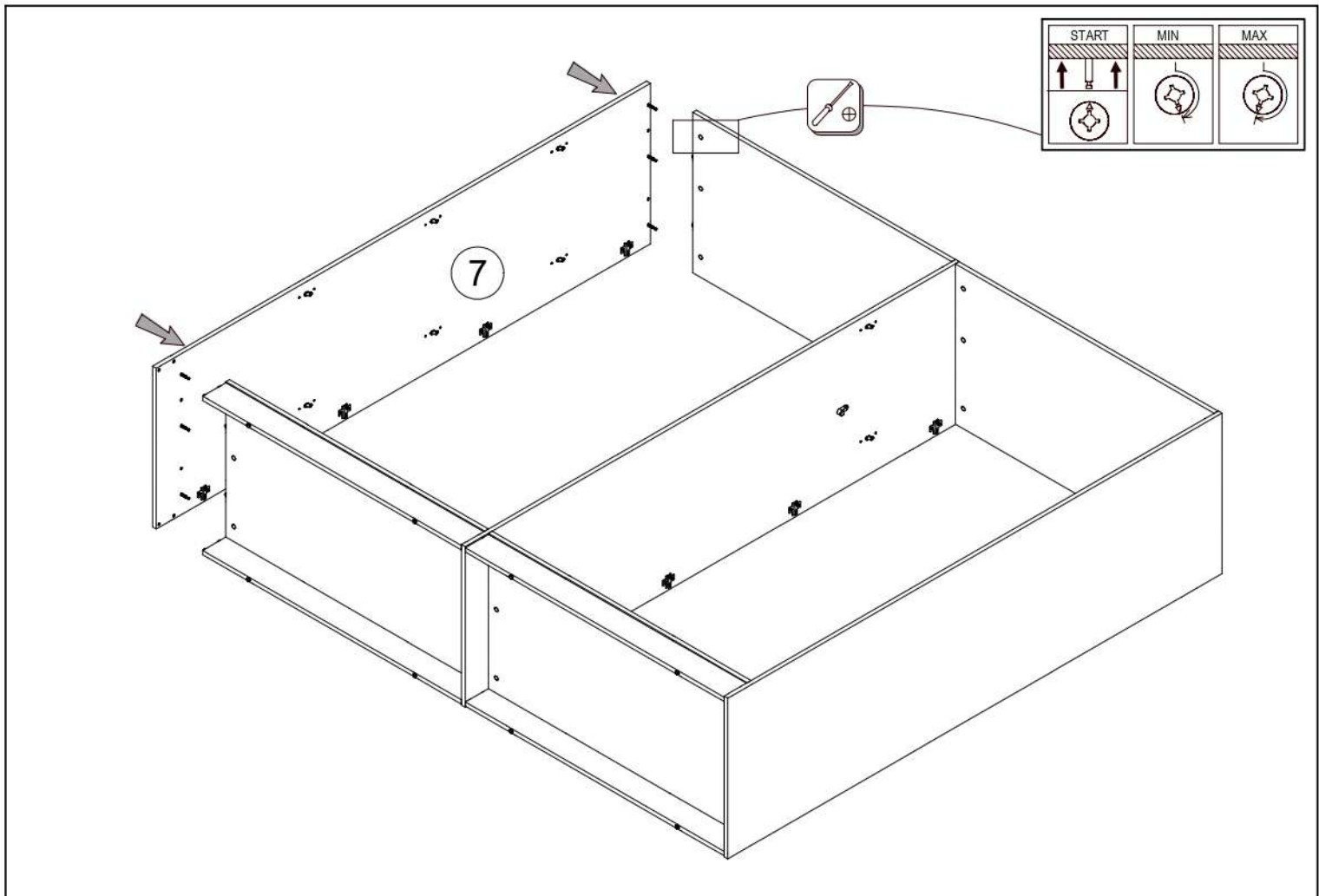
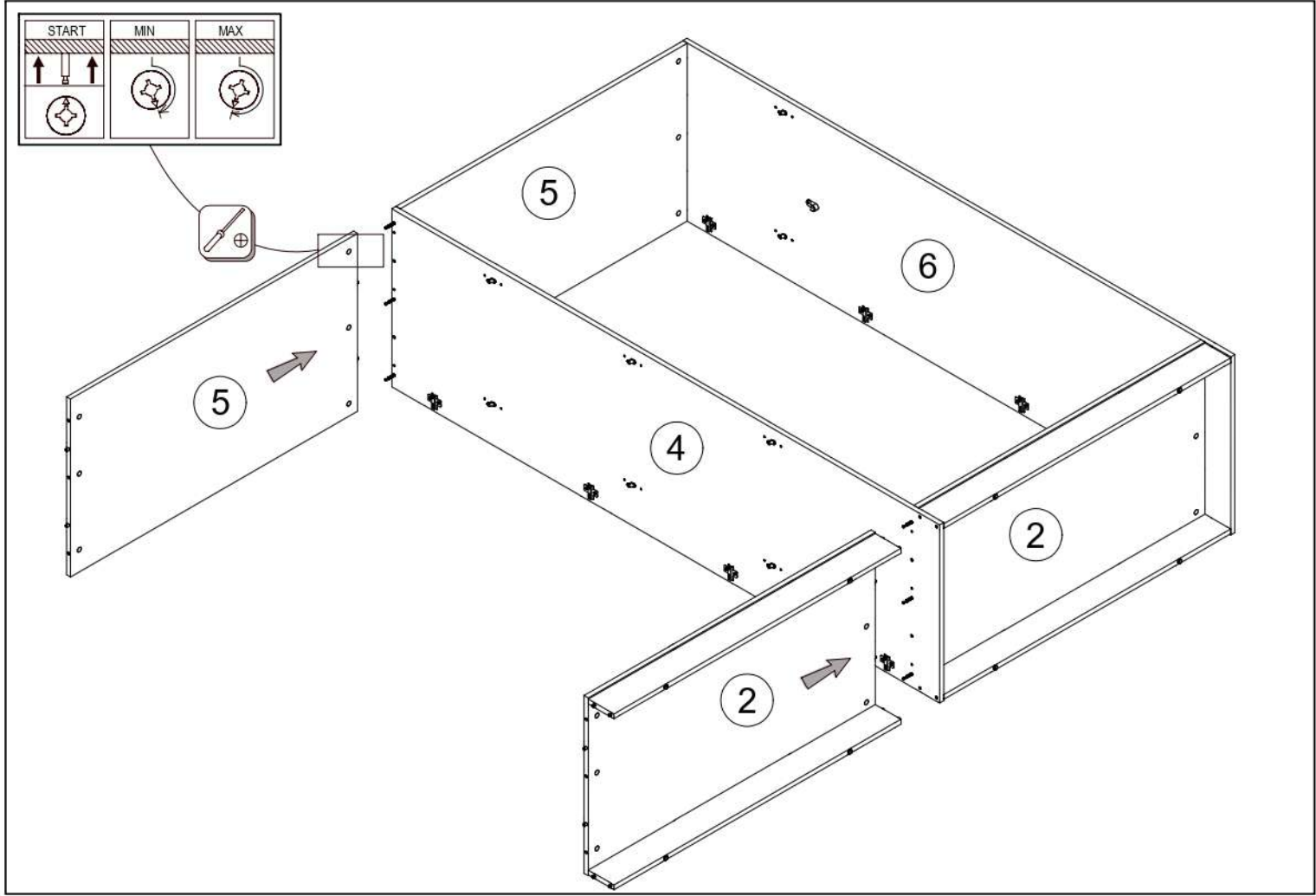



		
Ø1,2x20	Ø2,5x16	
C 100x	U 20x	V 20x

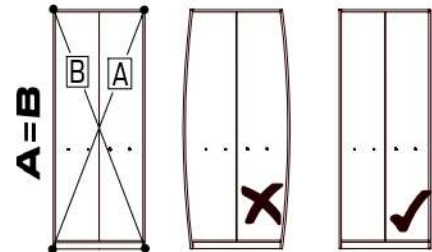
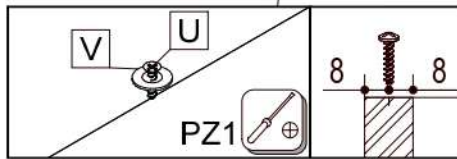
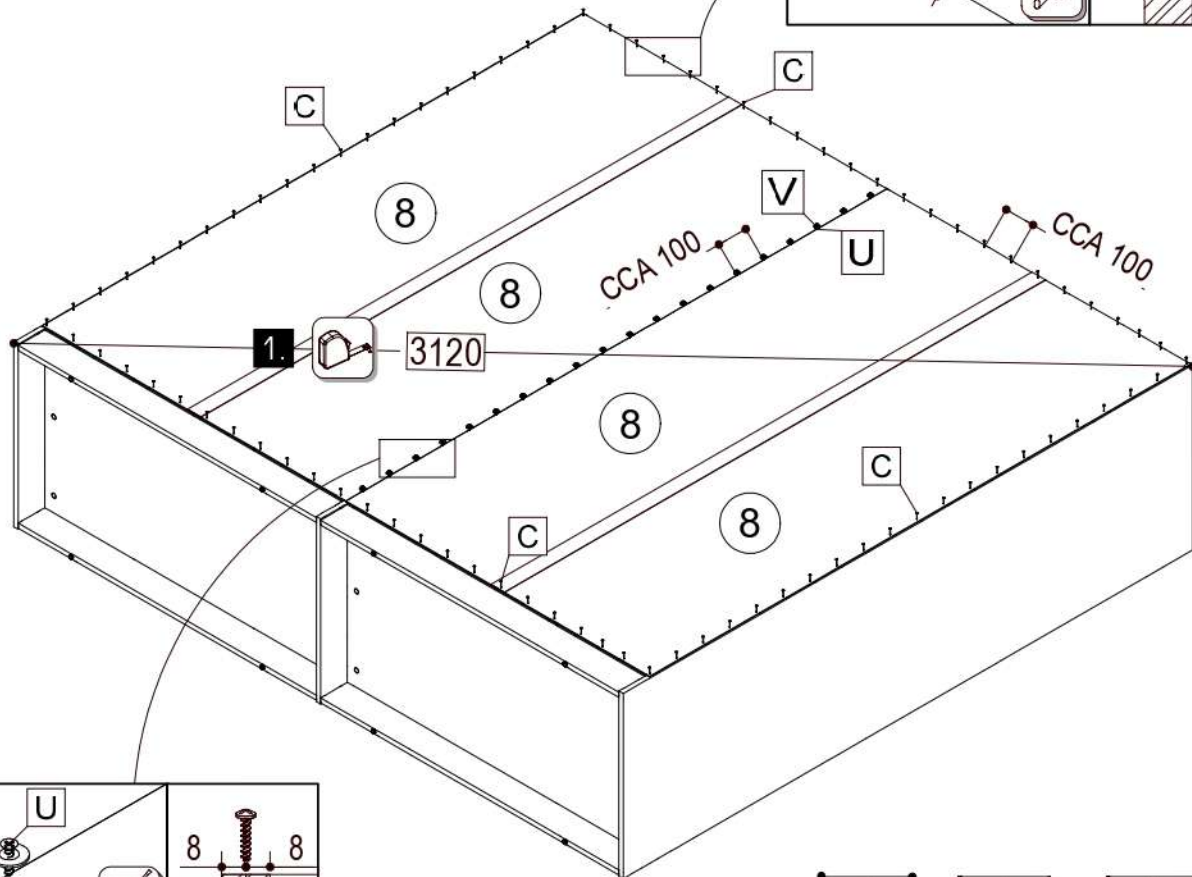
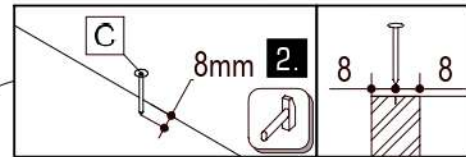

Upozornenie! Pevnost steny sa musí pred montážou bezpodmienečne skontrolovať. Univerzálne hmoždenky, ktoré sú obsiahnuté v balení, používajte jedine pre pevné murivo ako je betón/tehla. Hmoždenky sa nesmú používať v prípade ľahkého stavebného muriva, dutina tehla, u sádrokartónových dosiek alebo iných konštrukcií rámu. U týchto murív je nutné použiť špeciálne hmoždenky! Tieto je možné dostať v špeciálnych predajniach so stavebným materiálom (stavebniny). Pri nedodržaní pokynov nepreberajú výrobcovia/predajci a dodávateľia zodpovednosť za vzniknuté škody.

Upozornění! Před montáží je nutné zkontrolovat stav stěny. Přiložené univerzální hmoždinky jsou určeny pouze k použití pro pevné zdivo jako beton/cihly. Hmoždinky do zdi se nesmí používat u dutinová cihla, zdiva jako pórovitý stavební kámen, sádrokartónová deska nebo jiný měkký materiál. U těchto zdív jsou nutné použít speciální hmoždinky! Jsou k dostání v speciálních prodejních se stavebním materiálem. Při nedodržení těchto pokynů výrobce/prodejce a dopravce neručí za způsobené škody.

Pažnja! Prije montaže obvezno provjerite svojstvo zida. Priklozene univerzalne tiplje namijenjene su isključivo za masivne zidove od betona/opeke. Tiplje za masivne zidove ne smiju se koristiti za zidove kao npr šupljina opeka laki sastavni elementi, gips-kartonске ploče ili drugi modularni načini gradnje. Za te zidove potrebne su eventualno specijalne tiplje! Iste su dostupne u specijaliziranim trgovinama građevinskim materijalom. U slučaju nepridržavanja prethodno navedenih napomena, proizvođač/trgovac i uvoznik ne preuzimaju odgovornost!

Achtung! Die Wandbeschaffenheit ist vor der Montage unbedingt zu prüfen. Die beigelegten Universaldübel sind ausschließlich nur zur Verwendung für festes Mauerwerk wie Beton/Ziegel. Die Mauerdübel dürfen nicht bei Mauerwerk wie Hohlraumziegel, Leichtbausteine, Gipskartonplatte oder anderer Rahmenbauweise verwendet werden. Bei diesen Mauerwerken sind gegebenenfalls Spezialdübel zu verwenden! Diese sind in einem Fachgeschäft (Baumarkt) erhältlich. Bei Nichteinhaltung wird seitens Produzenten/Händler und Importeur keine Haftung übernommen.

Vigyázat! Szerelés előtt a falfelületet felültenül vizsgálja meg. A mellékelt univerzális tiplje kizárólag stabil falazathoz használható mint például beton/tégla. A fal tiplje nem használható könnyű építőkövekhez, üreg tégla, gipszkarton lapokhoz vagy más fázvas építményekhez. Ezekhez a falfelületekhez csak speciális tiplje használhatóak, melyek szaküzletekben (barkácsruházakban) beszerezhetőek. Fentiek figyelmen kívül hagyása esetén a gyártó/kereskedő vagy forgalmazó nem vállal felelősséget.

Uwaga! Ścianę należy sprawdzić przed montażem. Dołączone uniwersalne kołki rozporowe są odpowiednie tylko do stosowania w mocnych murach, takich jak beton lub cegła. Nie rób z pomocą kołków rozporowych murowanych, takich jak pustak, lekka kostka, powierzchnie takie jak płyty gipsowo-kartonowe lub inne systemy ram. Jeśli dotyczy, muszą to być określone kołki rozporowe być użyty! Są one dostępne w specjalistycznym sklepie (sklepie ze sprzętem) niezgodność, producent / sprzedawca lub importer nie ponoszą odpowiedzialności.

Prudent! Zidul trebuie examinat înainte de asamblare prizele de perete sunt adecvate numai pentru utilizarea în zidărie fermă, cum ar fi betonul bloc sau cărămidă. Nu folosiți zidăria zidurilor de perete, cum ar fi cărămida goală, blocul ușor, suprafețe cum ar fi gips-carton sau altă înclădare sisteme. Dacă este cazul, trebuie folosite anumite prize de perete! Acestea sunt disponibile la un magazin specializat (magazin de hardware). În caz de nerespectare, producătorul / vânzătorul cu amănuntul sau importatorul nu își asumă răspunderea.

Увага! Стан стіни необхідно перевірити перед установкою. Укладені універсальні дюбелі призначені лише для використання з фіксованими Кладка, як бетон / цегла. Анкери для стін не повинні використовуватися для кладки Порожни цегли, легкі будівельні блоки, гіпсокартон або інша каркасна конструкція бути використаними. З цією кладкою можуть застосовуватися спеціальні дюбелі використання! Вони доступні в спеціалізованому магазині (магазині апаратних засобів) Виробник / дилер та імпортер не несе відповідальності.

Opozorilo! Pred vgradnjo je treba brezpogojno preveriti trdnost stene. Za trdne zidove, kot sta beton ali opeka, uporabljajte samo zatiče, ki so vključeni v paketu. Čepov ne smete uporabljati za lahke grajene zidake, votlo opeko, mavčnokartonske plošče ali druge okvirne konstrukcije. Za te zidane konstrukcije je treba uporabiti posebne čepi! Te je mogoče dobiti v trgovinah z gradbenim materialom. V primeru neupoštevanja navodil proizvajalci/prodajalci in izvajalci ne prevzemajo odgovornosti za morebitno povzročeno škodo.

P 4x	W 2x	Y 2x	Z 2x

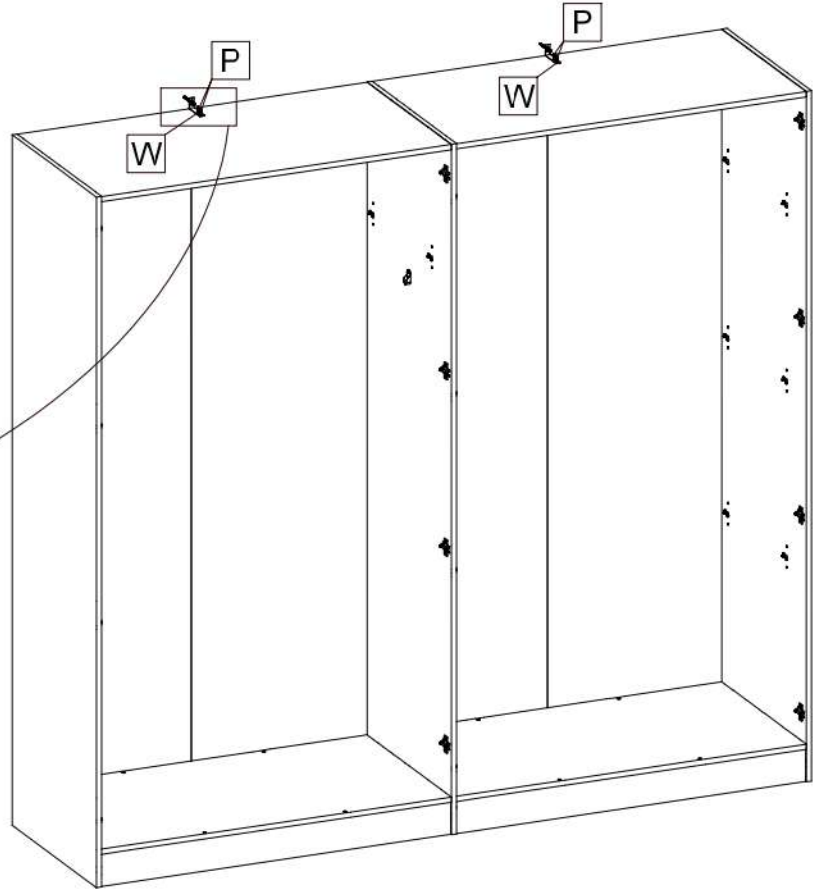
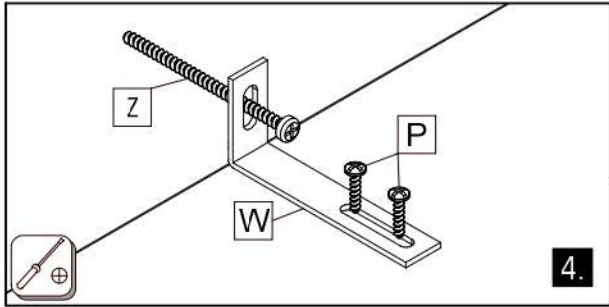
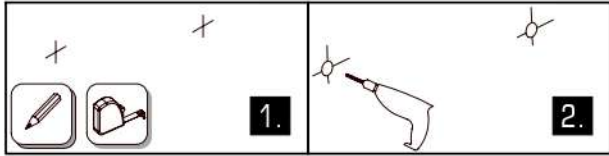
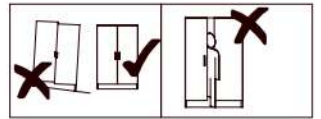

M 1x	Q 12x

